



## **MARS-V2-90 IS-X Range Hood**

### **Installation Guide Operation Manual**



# IMPORTANT REMINDERS

## USE

- This range hood has been designed for domestic household use only to eliminate smoke and odor.
- Commercial usage for café's, restaurants, and other similar establishments will void the warranty of this product.
- Never use the range hood for purposes other than extracting kitchen smoke and odor.
- Never leave high open flames under the hood when it is in operation.
- This range hood is not a toy. Please keep children and other unauthorized persons not instructed to use the hood away from the appliance.

## INSTALLATION

- The manufacturer will not be held liable for any damages resulting from incorrect or improper installation.
- Installation must be carried out by a qualified and authorized ELBA Service Technician.
- The minimum safety distance between the cooktop and the range hood is 650 millimeters (mm).
- Check that the electrical supply from the outlet to which it is to be plugged in is matching with the requirements of the hood, as indicated by the product label on the range hood.
- The exhaust pipe should have a minimum diameter of 150 millimeters (mm)

## MAINTENANCE

- Switch off and unplug the appliance from the main power supply before carrying out any maintenance work. (When disconnecting the appliance, do not pull on the cord as it might cause a short circuit. Instead, hold the plug and apply pressure on it when pulling from the wall socket.)
- Clean the hood using a damp cloth and a neutral liquid detergent.
- Clean and/or replace the filters after the specified time period.
- There is risk of fire if cleaning is not carried out in accordance with the guidelines and instructions as highlighted in the section "CLEANING AND MAINTENANCE".

## LIABILITY

- The Manufacturer will not be held liable for any damages incurred as a result of the improper installation, usage, and maintenance of this product.

## INSTALLATION

### Important Notes:

- The hood should be placed at a distance of 65-75cm from the cooking surface for maximum performance.
- The exhaust pipe should have a minimum diameter of 150 millimeters (mm)
- Install the bracket on a hard and sturdy surface (with bracing if possible). Make sure that the surface screws are long enough to bite into the ceiling and tightened with enough torque.
- Make sure that the range hood is aligned properly, not tilted in either a sideward or front/backward direction.
- The ceiling must bear at least 40 kilograms (Kg) of weight.
- The thickness of the ceiling must be  $\geq 30\text{MM}$ ,

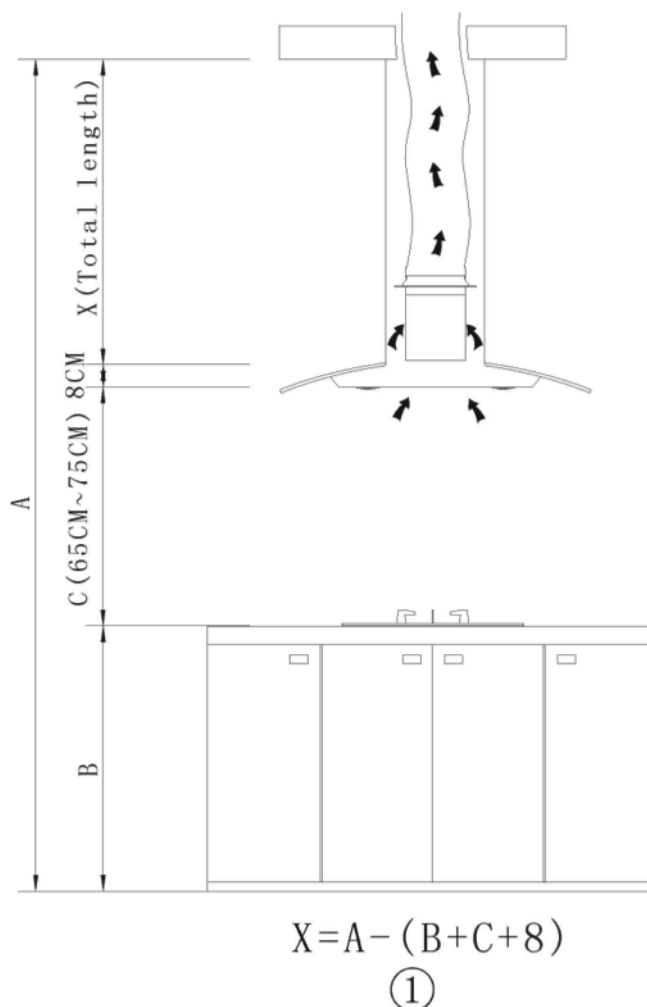

### Installation Steps:

1. Drill one (1) 170mm round hole in the centre of the ceiling for the exhaust pipe as seen in pic 2.

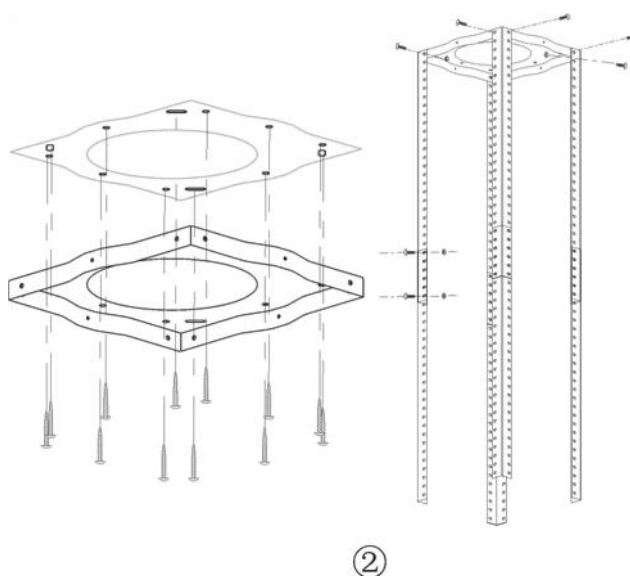

*\*Note that this should be the centre of the Island hood directly below the cooktop.*

2. According to the hanging board, drill 12 pcs of ST6 \* 40mm flat screws that will be used to fix the hanging board onto the ceiling as seen in pic 2.
3. Then, 8 pcs of M4\*10 screws and M4 nuts with gaskets will be used to connect the angular bar into the hanging board mounted on the ceiling as seen in pic 2.
4. If the height is not enough to meet the minimum requirements, an additional section can be added to lower the body of the range hood.
5. Calculate the length of the angle bar, and use 16 pcs M4\*10 flat screws and M4 nuts with gaskets to connect another angular bar with the first section.

*\*Note: The overlap length of angular bar should be at least 100mm to maintain rigidity and stability of the lower section.*

6. Make sure that the exhaust pipe is fitted inside the 170mm opening as seen in pic 3.
7. Use 4 pcs ST4\*8 flat screws to connect the upper/internal chimney onto the hanging board, then put the external chimney. Two (2) hooks will be used to hold up the chimney in order to install the lower sections, as seen in pic 4.
8. Use 4 pcs ST4\*8 flat screws to install the outlet on the body casing, as seen in pic 5.

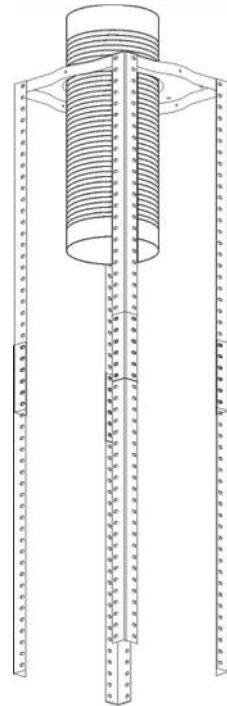

③

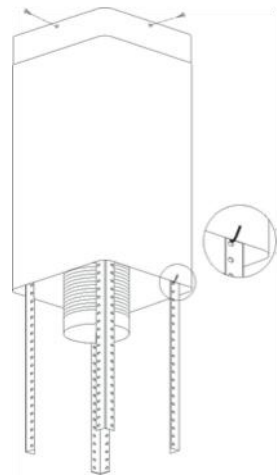

④

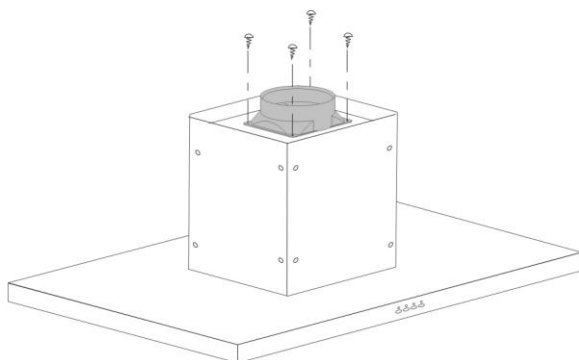

⑤

9. Hold up the hood and insert it in between the angular bars. Align it properly and use 16 pcs M4\*10 flat screws to mount the body of the hood to the angular bars, as seen in pic 6.
10. Lower the exhaust pipe onto the duct / outlet of the hood and fasten properly to make sure that exhaust air does not leak through the sides.
11. Remove the hooks supporting the chimney cover and lower the chimney cover to finish off the installation.

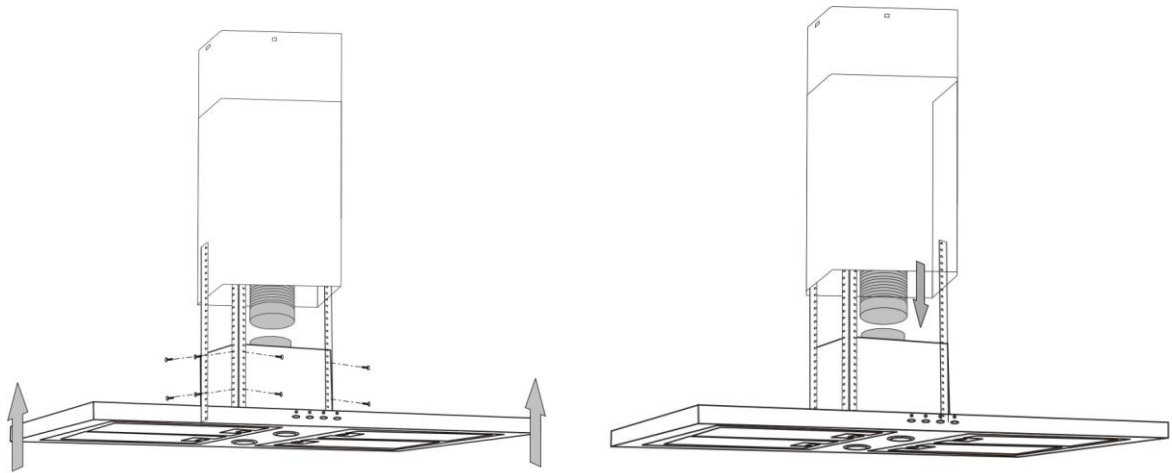

⑥

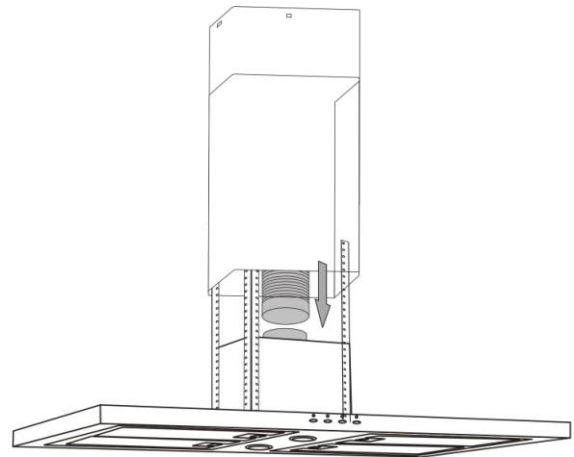

⑦

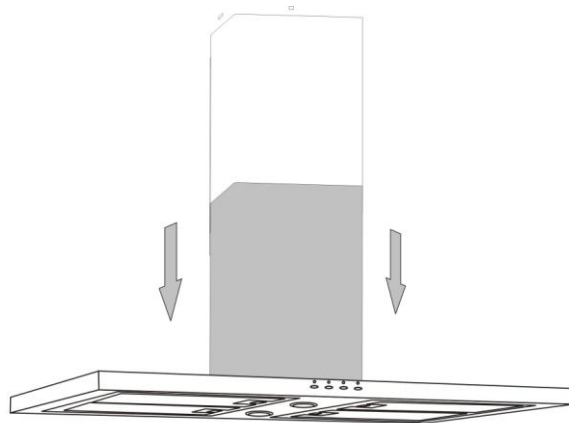

⑧

# OPERATION

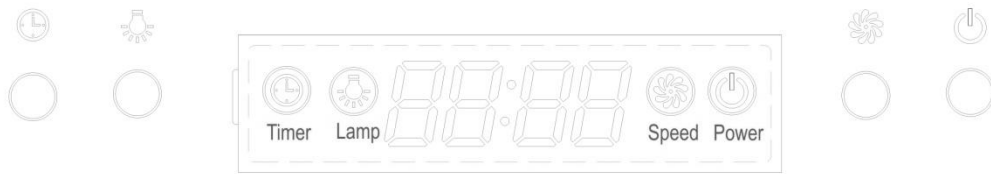

## LCD Display Symbols:

 - Timer Indicator

 – Lamp Indicator (displayed when range hood is on)

 – Speed Indicator

 – Power Indicator (displayed when range hood is on)

## Touch Pad Operation:









“ Light  ” – Press to activate and deactivate light.  
(This functions as the – or decrease button in Time / Timer setting)

“ Speed  ” – Press to activate motor and select speed setting.  
(This functions as the + or increase button in Time / Timer setting)





“ Power  ” – Press to turn the unit on/off.

“ Timer  ” – This activates 2 functions: Timer and Time Delay.

### ➤ Time Function

- Hold the  key for 2-3 seconds
- The  display will flash indicating adjustment mode
- Press the  and  buttons to adjust desired time
- Press the  again to switch adjustment to minute setting
- Press the  and  buttons to adjust desired time
- Press the  again to finalize settings and exit mode

- Time Delay – This range hood is equipped with a time delay function that allows you to set the duration when the hood will shut off after a certain time period.

- Press the  once to activate delay function.
- Press the  and  to set the time delay.
- Press the  again to confirm after the desired time is set.
- The LCD display will show the remaining time until the unit is shut off.

## CLEANING AND MAINTENANCE

---

### Aluminium Filters

This unit comes equipped with removable aluminium filters that are to be cleaned on a regular basis in order to maintain the performance and longevity of the hood.

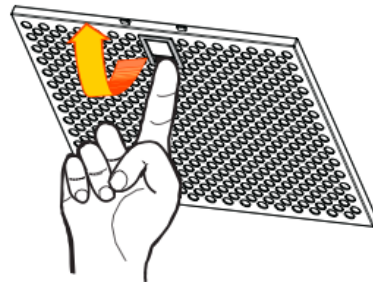

**Instruction:** To remove the filters, press the clip located at the front, pull down the filters, and release the clip.

### Cleaning the Filters

1. Prepare a large basin with 40-60 degrees Celsius of warm water and add a mild detergent to mix with the water.
  - Note: DO NOT use any corrosive detergent when cleaning.
2. Soak the aluminium filters for two (2) to five (5) minutes in the basin to loosen the build-up of oil and grease.
3. Use a soft brush with fine bristles to gently scrub the aluminium filters. Apply moderate strength, so as not to damage the filter.
4. Allow the filter to air dry until it is completely free from any moisture.

**Recommendation:** Clean the filters at least once every month for regular usage, or more frequently for heavy usage. Visually inspect the filter for trapped oil and grease on a regular basis in order to maximize the performance of the hood.

**Warranty Exemption:** The aluminium filters are a consumable item and are not covered by the warranty of this item. Any defects caused by the negligence in cleaning the filters will also void the warranty of the hood.

## **LED Lights**

This unit comes equipped with energy efficient LED bulbs.

**Instruction:** Please call the service centre for the replacement of the LED bulb modules. It is suggested that you do not try to replace this yourself, as it might cause electrical shock.

**Warranty Exemption:** The incandescent bulbs are a consumable item and are not covered by the warranty of this item.

## **Cleaning the Body Casing**

*Do not use harsh / aggressive chemicals and rough sponges that can damage the material finish of the range hood.*

1. Use a soft damp cloth to wipe the body casing to remove dust particles.
2. After which, use a dry cloth wipe down any excessive moisture left by the damp cloth.
3. You may use a dedicated stainless steel cleaner (for stainless steel finishes) to finish off the cleaning process.